



NiGLON

Industrial Accessories

ISS634P Stainless Steel Rotary Isolators

Technical Drawing

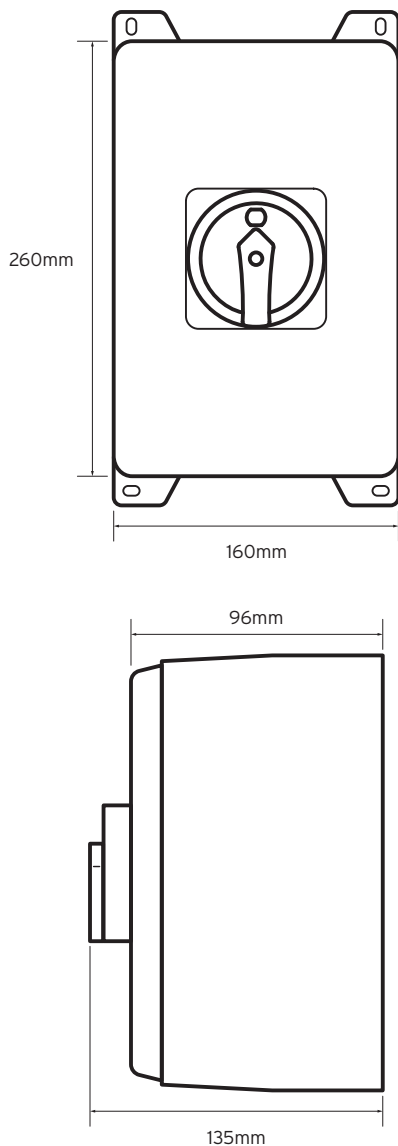

Technical Specifications

Standards	EN60947-3
Rated Current	63A
No. of Poles	4
Rated Insulation Voltage(V)	690V
Rated Operating Current(A)	63
AC-22A	63
AC-23A	63
AC-3	50
Rated Voltage(Ue)	440V
Rated Power Control(KW)	22
Rated short-time withstand current(Icw)	800A
Connect Wire	16mm ²
Screw Torque	1.2 N.m

Enclosure Characteristics

Overall Dimensions HxWxD	260x160x96mm
Depth with switch	135mm
Degree of IP	IP65
Colour	RAL7035

Wiring Diagram

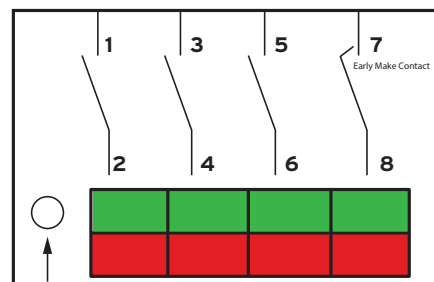

Note 7 = Early Make Contact