

PANEL COMPONENTS

MULTIFUNCTION BEACON MB12



Multi colour beacon with 22mm Ø connection. Flashing and steady LED indication in the same unit. Heat resistant polycarbonate construction. Integral sounder. Pre wired connections

General Characteristics

Operating voltage	12V AC/DC
Rated voltage Ui	300V
Electrical life	10 000 hours
Power consumption (red)	408mW
Power consumption (yellow)	552mW
Power consumption (blue)	360mW
Power consumption (green)	360mW
Power consumption (white)	960mW
Power consumption (buzzer)	480mW
Overall diameter	55.3mm
Overall height	122.8mm
Lens height	64.8mm
Ingress protection	IP65
Operating temperature	-5 - +40°C
Buzzer sound level	90 dB built in
Weight	0.38Kg

Available Accessories

MBA-AB	Contact block only 1N/O
MBA-PA	Pipe adaptor
MBA-WB	Wall bracket

Wiring Diagram

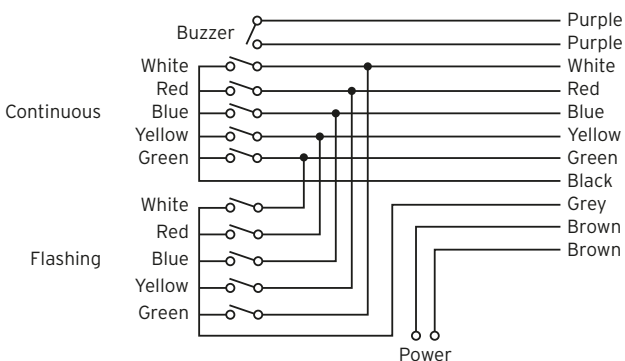

Technical Drawing

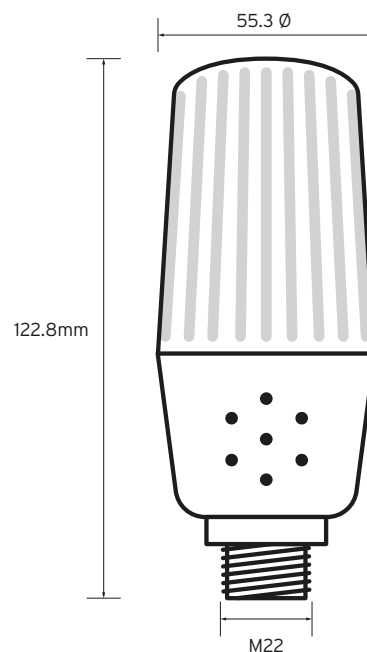

Additional Information

This product is for use by skilled persons or instructed persons. The installation of this product must comply with current IEE regulations. Terminals, including those factory fitted, must be checked for correct tightness before commissioning. All terminals should be periodically checked for correct tightness. The data herein serves only to describe the product and should not be regarded as representing guaranteed properties in the legal sense. We reserve the rights of modification, whilst every care has been taken in ensuring the accuracy of this catalogue, the Supplier accepts no liability whatsoever for any eventuality arising from errors or omissions within its catalogues, brochures or within any online presence.