

NSP642 10AX Light Switch

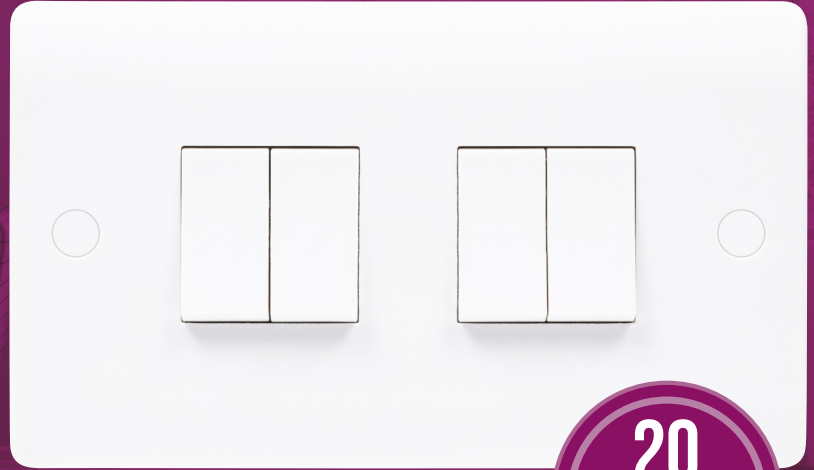

**20
YEAR
GUARANTEE**

A new take on traditional moulded wiring accessories manufactured in bright white Urea.

Technical Drawing

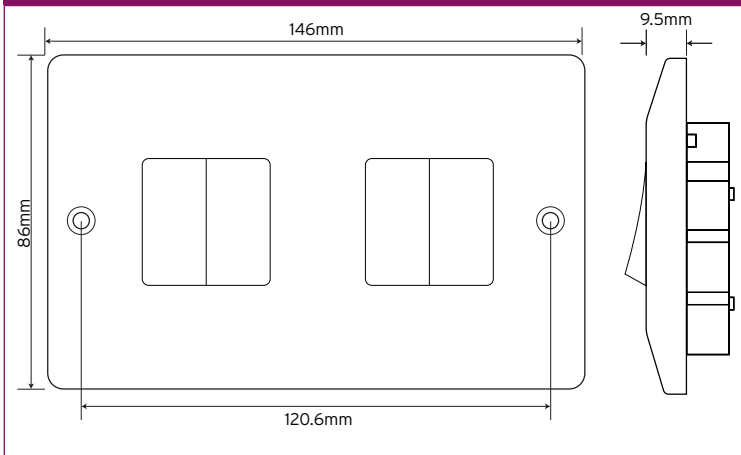

Technical Specifications

No. Gangs and Ways	4 Gang, 2 Way
Material Composition	Front Plate - Urea Rear Housing - Nylon Terminals - Brass, Terminal Screws - Steel & Yellow Passivated Internal Mechanism - Formed Press Brass Silver "on-lay" Copper / Brass Contacts
Voltage	240V~ 50Hz
Current Rating	10AX (suitable for inductive loads)
Terminal Size	3.5mm ϕ
Torque Value	0.4Nm
Cable Size	4 x 1.5mm ² or 2 x 2.5mm ²
Back Box Depth	25mm
Modular	Yes
Warranty	20 Years
Anti Microbial Certified	Yes
IP Rating	IP20
Operational Temperature	-5° to +40°C
Standards	The Low Voltage Directive 2006/95/EC BS EN 60669-1:1999 + A1:2002 + A2:2008 Modified ISO 22196
Dimensions	86x146x9.5mm (HxWxD)