

SP632

3 Gang 2 Way

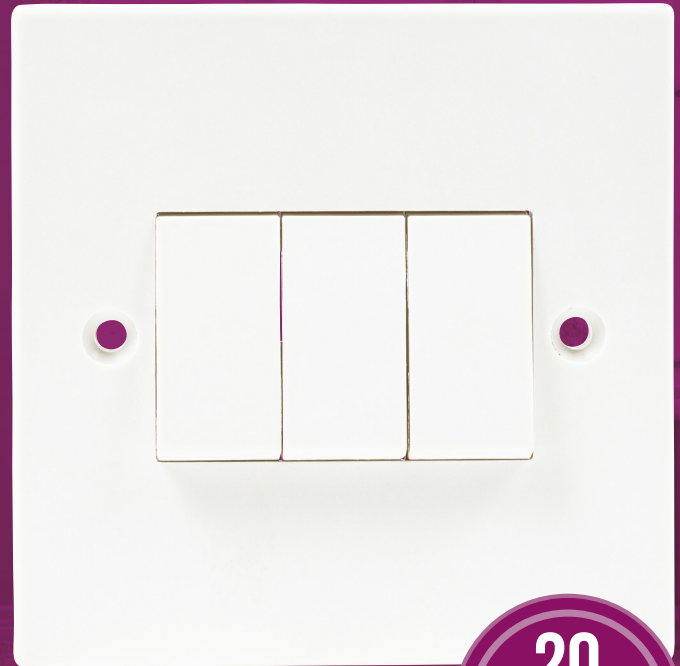

**20
YEAR
GUARANTEE**

A white, square-edged, moulded accessory manufactured in a robust urea construction. Arctic Edge offers traditional design values for new, or existing installations.

Technical Drawing

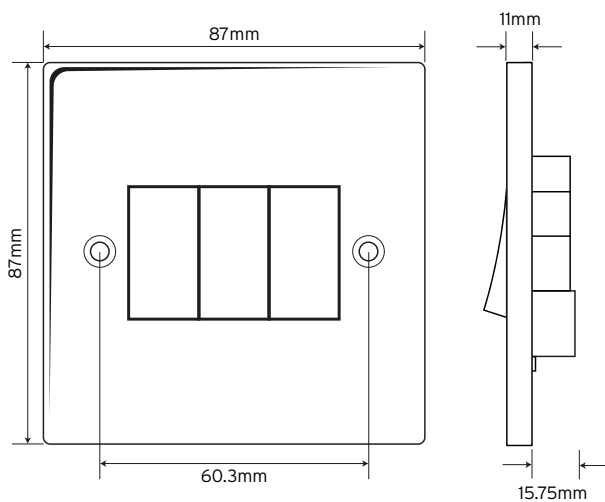

Technical Specifications

Material Composition:

Front Plate	Urea
Rear Housing	Urea
Terminals	Brass
Terminal Screws	Steel & Yellow Passivated Silver "on-lay" Copper/Brass Contacts
Voltage	240V ~ 50Hz
Current Rating	10AX (suitable for inductive loads)
Terminal Size	3.5mm Ø
Torque Value	0.5Nm
Cable Size	4x1.5mm ² or 2x2.5mm ²
Back Box Depth	16mm - 47mm
Warranty	20 years
IP Rating	IP20
Operational Temperature	-5 ° to +40 °C
Standards	BS EN 60669-1:1999 + A1:2002 + A2:2008