

2PCO Miniature Relays // 8 Pin

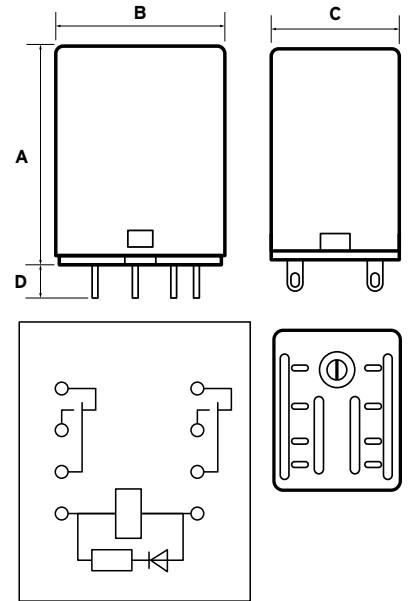

Relay and socket easily fit together using the 8 pin connection system.



Part No.	Nominal Coil Voltage	Dimensions				Qty
		A (mm)	B (mm)	C (mm)	D (mm)	
2P1012D	12V DC	35.2	28	21.3	6.5	1
2P1024D	24V DC	35.2	28	21.3	6.5	1
2P1024	24V AC	35.2	28	21.3	6.5	1
2P10120	110V AC	35.2	28	21.3	6.5	1
2P10230	230V AC	35.2	28	21.3	6.5	1

Specifications //

- Standard of Compliance - EN 60947-4-1
- Changeover Pinout - Universal 2 pole
- Contacts - 6.5A AC1
- Low Consumption Coil - DC 900mW & AC 1.2VA
- Flag indicator
- Lockable test button
- LED indicator

Socket for 2PCO Miniature Relays // 8 Pin

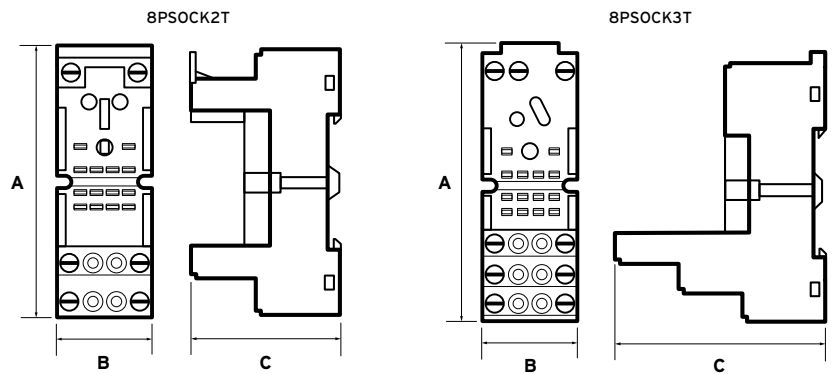

Part No.	No. of Tiers	Dimensions			Qty
		A (mm)	B (mm)	C (mm)	
8PSOCK2T	2	76	27	42.4	1
8PSOCK3T	3	76	27	61	1

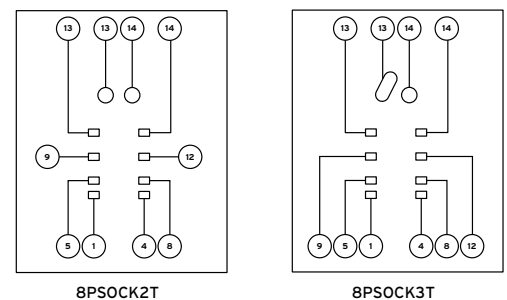

Specifications //

- Standard of Compliance - EN 60947-4-1
- Diode Modules - Accepted

4PCO Miniature Relays // 14 Pin



Relay and socket easily fit together using the 14 pin connection system.

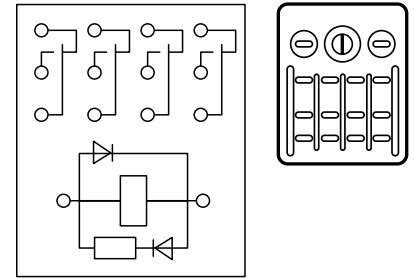
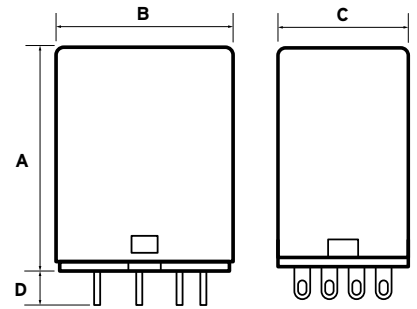

Specifications //

- Standard of Compliance - EN 60947-4-1
- Changeover Pinout - Universal 4 pole
- Contacts - 5A AC1
- Low Consumption Coil - DC 900mW & AC 1.2VA
- Flag indicator
- Lockable test button
- LED indicator

Data Sheet



Download

Part No.	Nominal Coil Voltage	Dimensions				Qty
		A (mm)	B (mm)	C (mm)	D (mm)	
4P612D	12V DC	35.2	28	21.3	6.5	1
4P624D	24V DC	35.2	28	21.3	6.5	1
4P624	24V AC	35.2	28	21.3	6.5	1
4P6120	110V AC	35.2	28	21.3	6.5	1
4P6230	230V AC	35.2	28	21.3	6.5	1

Socket for 4PCO Miniature Relays // 14 Pin



14PSOCK2T

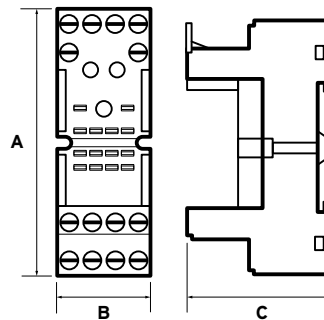

14PSOCK3T

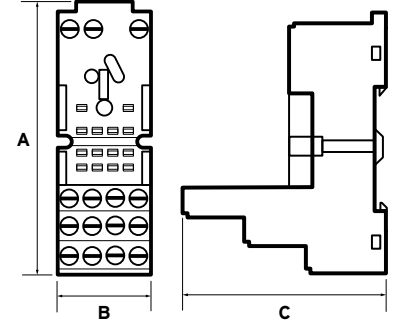

Data Sheet



Download

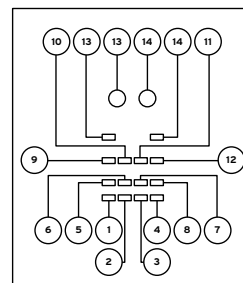

14PSOCK2T

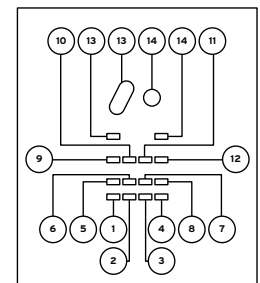

14PSOCK3T

Specifications //

- Standard of Compliance - EN 60947-4-1
- Diode Modules - Accepted

Part No.	No. of Tiers	Dimensions			Qty
		A (mm)	B (mm)	C (mm)	
14PSOCK2T	2	75.4	27.2	42.4	1
14PSOCK3T	3	75.4	27.2	61	1