

ENCLOSED SWITCHGEAR

ENCLOSED DC SWITCH DISCONNECTORS 4 POLE // POLYCARBONATE ISDC254



25A 4 pole switch disconnecter for use with DC voltage, rated at 1500V. TUV certification. Durable polycarbonate casing with M12 knockouts, suitable for MC4 connectors. Padlockable in the off position.

General Characteristics

Standards	EN60947-3
Number of Poles	4
Insulation Voltage	1500V DC
Rated current	25A DC-21B
Height of switch	160mm
Width of switch	83mm
Depth of Switch	86mm
Depth of Switch with handle	116mm
Connection type	Screw
Terminal Capacity flex/stranded	4mm ² / 6mm ²
Tightening torque	1.7 Nm
Ambient Temperature	50° C
Ingress protection	IP66 / 67

Technical Drawing

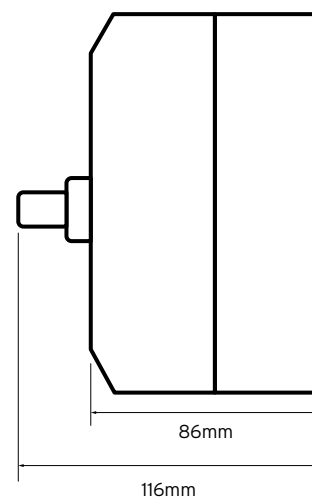
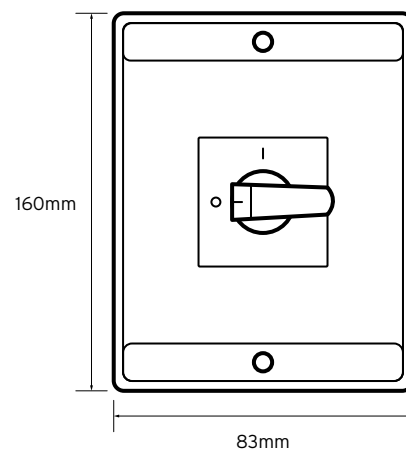

Wiring Diagram

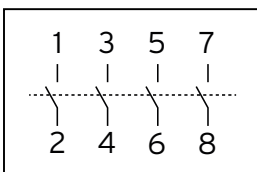

4 Pole

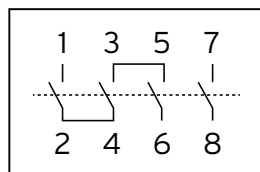

4 Pole with jumper link

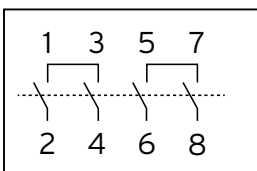

2 Pole in series
& 2 Pole in parallel

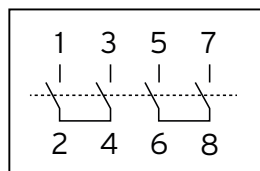

2+2 Pole

Additional Information

This product is for use by skilled persons or instructed persons. The installation of this product must comply with current IEE regulations. The IP rating of the unit can be compromised if the correct use of glands is not followed. Terminals, including those factory fitted, must be checked for correct tightness before commissioning. All terminals should be periodically checked for correct tightness. The data herein serves only to describe the product and should not be regarded as representing guaranteed properties in the legal sense. We reserve the rights of modification whilst every care has been taken in ensuring the accuracy of this catalogue, the Supplier accepts no liability whatsoever for any eventuality arising from errors or omissions within its catalogues, brochures or within any online presence.