

ENCLOSED SWITCHGEAR STAINLESS STEEL ROTARY ENCLOSED SWITCH DISCONNECTOR 4 POLE ISS634P



General Characteristics

Rated Current	EN60947-3
Rated Current	63A
Number of Poles	4
Rated Insulation Voltage (V)	690V
Rated Operating Current (A)	63
AC-22A	63
AC-23A	63
AC-3	50
Rated Voltage(Ue)	440V
Rated Power Control(KW)	22
Rated short-time withstand current(Icw)	800A
Connect Wire	16mm ²
Screw Torque	1.2Nm

Enclosure Characteristics

Overall Dimensions HxWxD	260x160x96mm
Depth with switch	135mm
Degree of IP	IP65
Colour	RAL7035

Wiring Diagram

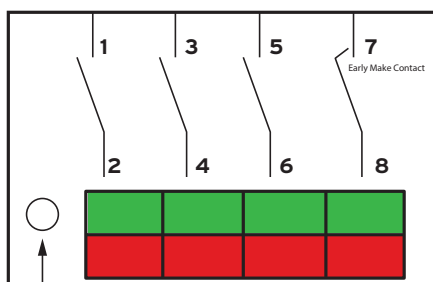

Note 7 = Early Make Contact

Technical Drawing

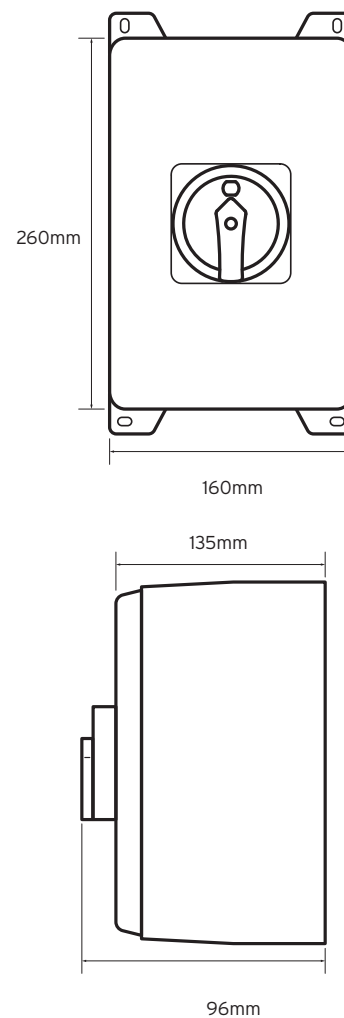

Additional Information

This product is for use by skilled persons or instructed persons. The installation of this product must comply with current IEE regulations. The IP rating of the unit can be compromised if the correct use of glands is not followed. Terminals, including those factory fitted, must be checked for correct tightness before commissioning. All terminals should be periodically checked for correct tightness. The data herein serves only to describe the product and should not be regarded as representing guaranteed properties in the legal sense. We reserve the rights of modification, whilst every care has been taken in ensuring the accuracy of this catalogue, the Supplier accepts no liability whatsoever for any eventuality arising from errors or omissions within its catalogues, brochures or within any online presence.