

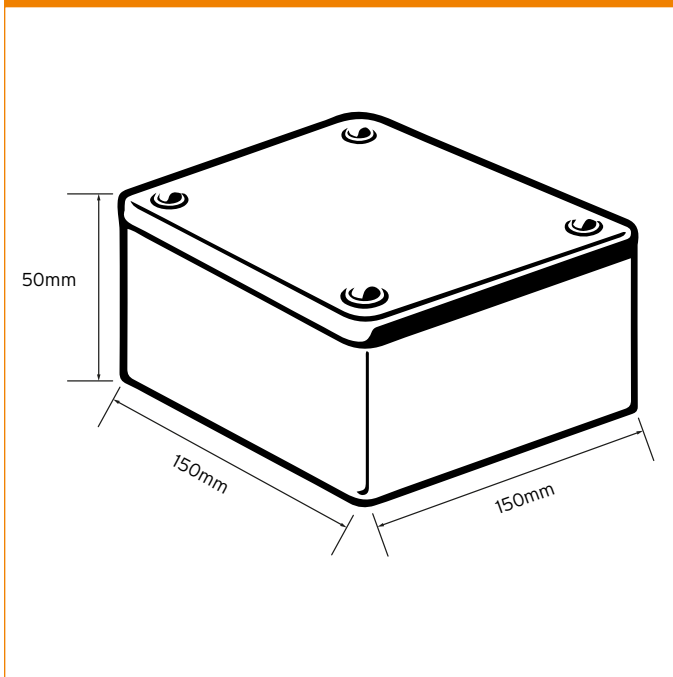

ABG662P

Adaptable Box

Technical Drawing



Technical Specifications

Finish	Galvanised
Material	Steel
Type	Without knockouts
IP Rating	IP54 (when used with rubber seal)
Standard of Compliance	BS 4568
Dimensions	150 x 150 x 50 (L x W x D)