

## P-SP611

### 1 Gang 1 Way



**30  
YEAR  
GUARANTEE**

A modern range of ultra-slim, smooth-edged, moulded wiring accessories-manufactured in a bright white Urea.

#### Technical Drawing

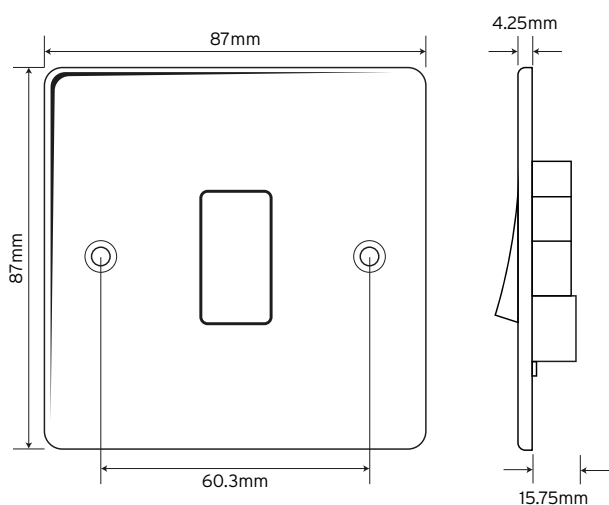

#### Technical Specifications

##### Material Composition:

<b>Front Plate</b>	Urea
<b>Rear Housing</b>	Urea
<b>Terminals</b>	Brass
<b>Earth Strap</b>	Mild Steel
<b>Terminal Screws</b>	Steel & Yellow Passivated Silver "on-lay" Copper/Brass Contacts
<b>Voltage</b>	240V ~ 50Hz
<b>Current Rating</b>	10AX (suitable for inductive loads)
<b>Terminal Size</b>	3.5mm Ø
<b>Torque Value</b>	0.5Nm
<b>Cable Size</b>	4x1.5mm <sup>2</sup> or 2x2.5mm <sup>2</sup>
<b>Back Box Depth</b>	16mm - 47mm
<b>Warranty</b>	30 years
<b>IP Rating</b>	IP20
<b>Operational Temperature</b>	-5 ° to +40 °C
<b>Standards</b>	BS EN 60669-1:1999 + A1:2002 + A2:2008