

niglon

Cable Management

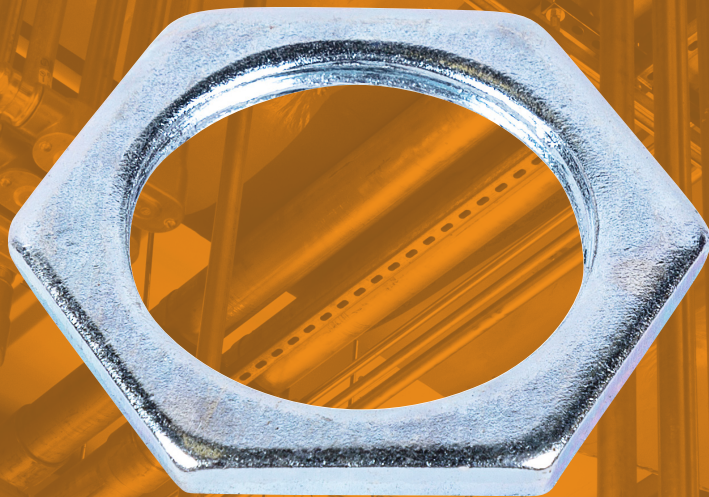

SLN32G Locknuts Light & Heavy Gauge

Technical Drawing

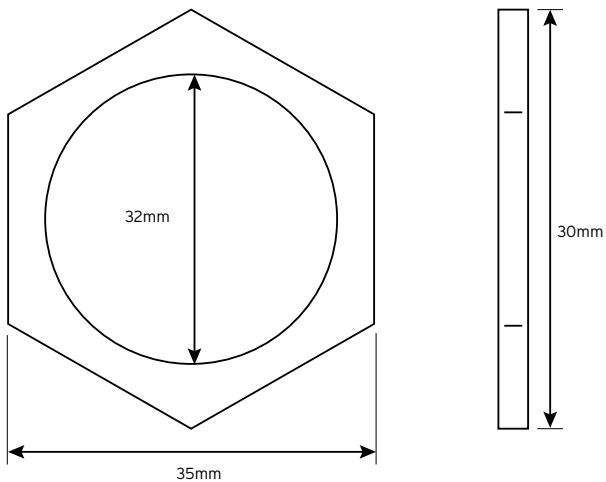

Technical Specifications

Standard of Compliance	BS EN 61386-1:2008
Finish	BZP
Size	32mm
Material	Galvanised Steel