

niGLON

Circuit Protection



M3CU18R

Isolator Controlled Consumer Unit Right Hand Incomer

Technical Drawing

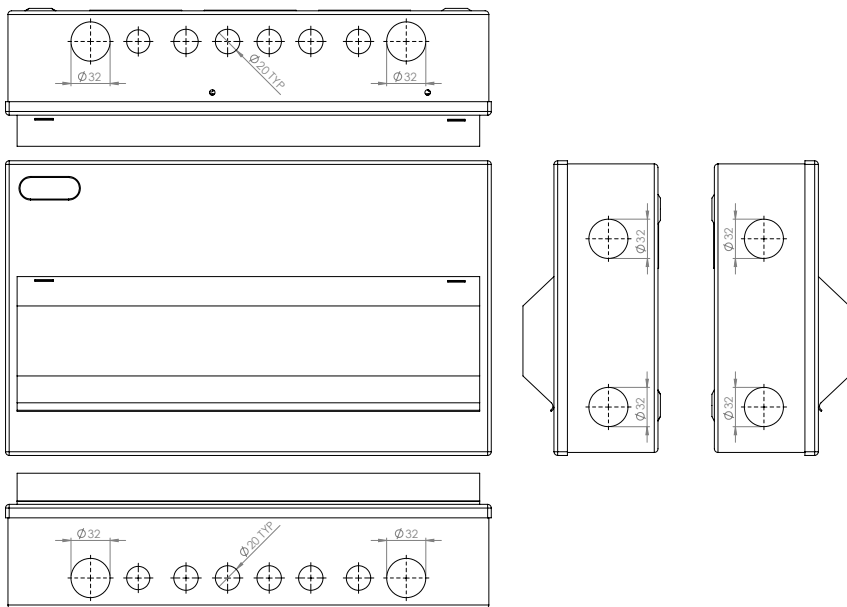

Technical Specifications

Material Composition	Steel
Colour	White RAL9010
No. of Free Ways	16 Free Ways
Relevant Standards	BS7671, BS EN 61439
100A Mains Incomer	Manufactured to EN60947:3
Dimensions	240 H x 397 W x 110mm D
Voltage Rating	230V
Current Rating	100A
IP Rating	IP20
Knockouts (Side)	M32, M20
Knockouts (Rear)	45 x 75 (x3)
Finish	Powder Coating
Mounting	Surface
IK Rating	IK05
Max Incoming Cable	35mm ²