

niglon

Earthing

AEC2/24 Damp Condition Clamps



Technical Drawing

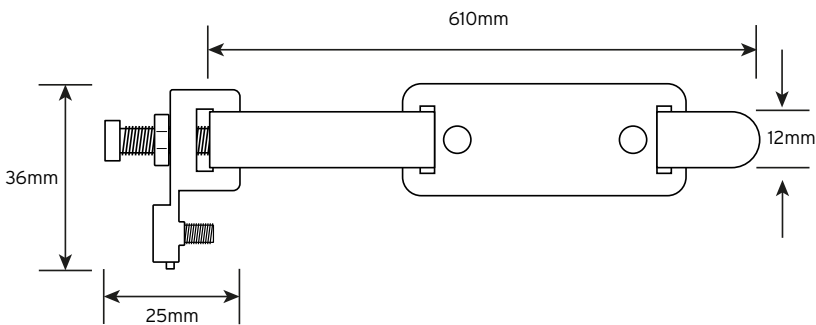

Technical Specifications

Pipe Diameter	180mm max
Maximum Conductor	A-D 1 x 10mm ²
Standard of Compliance	BS 951
Clamp Dimension	25 x 36 x 13mm (H x W x D)
Strap Dimension	12 x 610mm (W x L)