

niglon

Earthing

AEC4/2 Dry Condition Clamps



Technical Drawing

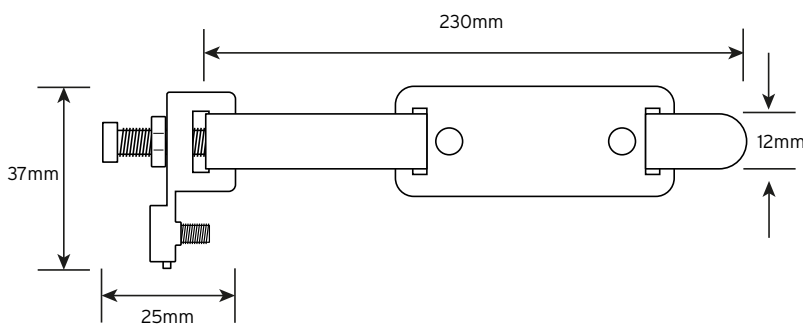

Technical Specifications

Pipe Diameter	32-50mm
Maximum Conductor	A-D 1 x 10mm ²
Standard of Compliance	BS 951
Clamp Dimension	25 x 37 x 13mm (H x W x D)
Strap Dimension	12 x 230mm (W x L)