

niglon Control & Automation

ENCLOSURES

PAINTED MILD STEEL ENCLOSURE MS403020



Wall mounting mild steel enclosure painted with epoxy-polyester powder paint. Standard RAL7035 colour. The polyurethane gasket keeps its profile over time to give a high degree of protection against water and dust. Door opens 125° and is reversible. One gland plate can be top or bottom. Welded earth studs top and bottom. Fitted, galvanised backplate has return edges for extra rigidity.

General Characteristics

Standards	BSEN 61439-1, BSEN 60529, BSEN 62208 & BSEN 62262
Ingress Protection	IP66
Height	400mm
Width	300mm
Depth	200mm
Enclosure Steel Thickness	1.2mm
Backplate height	354mm
Backplate width	254mm
Useable depth with backplate fitted	176mm
Backplate Thickness	2mm
Gland plate dimensions	217x 72mm
Number of Locks	1
Operating Temperature	-25°C to +55°C
Operating Relative Humidity at +20°C	90%
Operating Relative Humidity at +40°C	50%
Weight	6.7 Kg

Available Accessories

Plinth	PPS3020
Document Pocket	A4DOCW
Spare T Bit Key	STBK
Mild Steel Key Lock	MSKL
Spare Key	SPAK
Wall Mount Brackets (pack of 4)	SSWB
220mm Earth strap	ES22

Technical Drawing

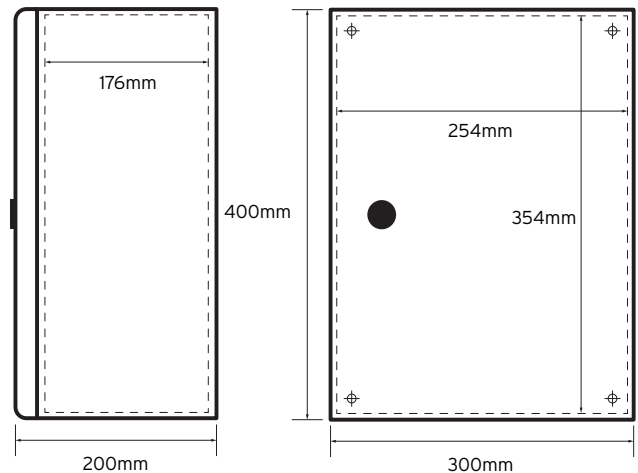

Additional Information

The data herein serves only to describe the product and should not be regarded as representing guaranteed properties in the legal sense. We reserve the rights of modification, whilst every care has been taken in ensuring the accuracy of this catalogue, the Supplier accepts no liability whatsoever for any eventuality arising from errors or omissions within its catalogues, brochures or within any online presence.