

ENCLOSURES

LARGE/FREESTANDING - GRP MX1073

Wall mounting or freestanding polyester enclosure intended for outdoor use. Standard RAL7035 colour. High resistance to harsh weather conditions, corrosion and impact. Easily machinable. Internal hinges allow 105° door opening. 3 point locking system operated by swing handles.



General Characteristics

Standards	BSEN 62208, BSEN 62262 & BSEN 60529
Material	Polyester
Flame test	960°C Glow Wire
Ingress Protection	IP55 / IK10
Height	1000mm
Width	750mm
Depth	300mm
Number of Locks	1
Operating Temperature	-30°C to +105°C
Thermal Class	A
Rated Voltage	1000V
Weight	21.2 Kg

Available Accessories

Document Pocket	A4DOCW
Polyester Backplate 893x655mm	PMX107
Metal Backplate 893x655mm	PMMX107
Large Ventilation Device	P-LVD
Swing handle with key lock	MSHK
Door stay	MSDO
Wall brackets	P-WBK

Technical Drawing

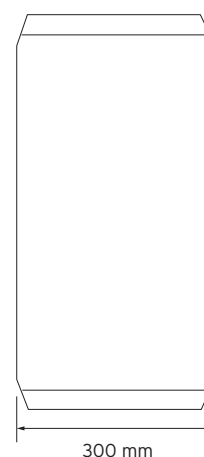
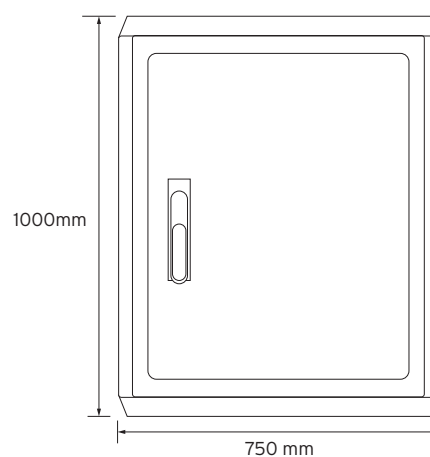

Additional Information

The data herein serves only to describe the product and should not be regarded as representing guaranteed properties in the legal sense. We reserve the rights of modification, whilst every care has been taken in ensuring the accuracy of this catalogue, the Supplier accepts no liability whatsoever for any eventuality arising from errors or omissions within its catalogues, brochures or within any online presence.