

ENCLOSURES

ABS PLASTIC - TRANSPARENT DOOR - PE241813C

Wall mounting ABS enclosure intended for outdoor use. Standard RAL7035 colour. Transparent door. Halogen free. Resistance to harsh weather conditions, corrosion and impact. Easily machinable. Triangular key lock. Complete with galvanised steel backplate and wall mounting brackets



General Characteristics

Body material	ABS Plastic
Door material	Polycarbonate
Flame test	650°C Glow Wire
Ingress Protection	IP65 / IK10
Height	240mm
Width	180mm
Depth	120mm
Useable depth with backplate fitted	98mm
Backplate	185x120mm
Number of Locks	1
Operating Temperature	-25°C to +60°C
Weight	1.1 Kg

Available Accessories

Document Pocket	A4DOCW
Key Lock with Butterfly Handle	PEKL

Technical Drawing

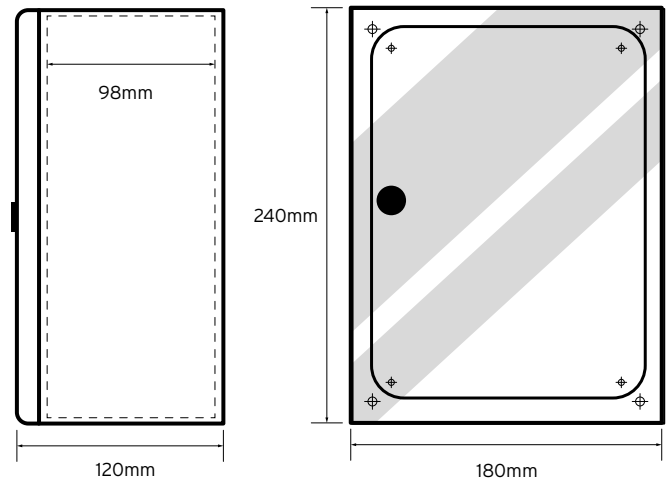

Additional Information

The data herein serves only to describe the product and should not be regarded as representing guaranteed properties in the legal sense. We reserve the rights of modification, whilst every care has been taken in ensuring the accuracy of this catalogue, the Supplier accepts no liability whatsoever for any eventuality arising from errors or omissions within its catalogues, brochures or within any online presence.