

niglon Control & Automation

ENCLOSURES

GRP GLAZED DOOR ENCLOSURE PG504020



Wall mounting polyester enclosure with glazed door intended for outdoor use. Standard RAL7035 colour. High resistance to harsh weather conditions, corrosion and impact. Easily machinable.

General Characteristics

Standards	BSEN 62208, BSEN 62262 & BSEN 60529
Material	Polyester
Flame test	960°C Glow Wire
Ingress Protection	IP66 / IK8
Height	500mm
Width	400mm
Depth	200mm
Useable depth with backplate fitted	173mm
Window Size (width x height)	221x381mm
Number of Locks	2
Operating Temperature	-30°C to +105°C
Thermal Class	A
Rated Voltage	1000V
Weight	5.5 Kg

Available Accessories

Document Pocket	A4DOCW
Polyester Backplate 458x360mm	PBP542
Metal Backplate 458x360mm	MBP542
Small Ventilation Device	P-SVD
Large Ventilation Device	P-LVD
Key Lock with Butterfly Handle	P-DL
Padlock Hasp	P-PH
Wall Fixing Kit	P-WFK

Technical Drawing

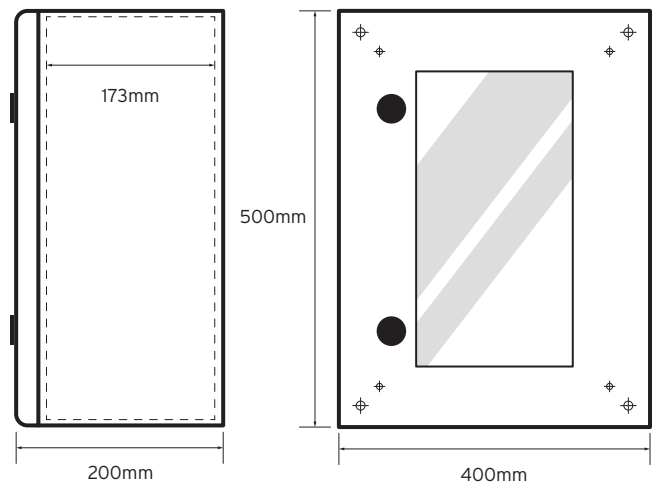

Additional Information

The data herein serves only to describe the product and should not be regarded as representing guaranteed properties in the legal sense. We reserve the rights of modification, whilst every care has been taken in ensuring the accuracy of this catalogue, the Supplier accepts no liability whatsoever for any eventuality arising from errors or omissions within its catalogues, brochures or within any online presence.